



Summer/Fall 2025



portals™

Portals Hardware has operated for over two decades with a steadfast commitment to offering exceptional hardware designs. Our products seamlessly integrate with your bathroom's overall aesthetic, creating harmony through thoughtful design elements and premium finishes.

Each Portals product represents the perfect marriage of form and function—where premium materials meet innovative engineering.

With our continued expansion into new product categories, we continue a tradition of excellence, bringing our distinctive design philosophy to every corner of your bathroom sanctuary.

At Portals, we believe hardware isn't merely functional—it's where exceptional quality, innovative design, and timeless beauty can unite to transform your space.



Stocked Finishes

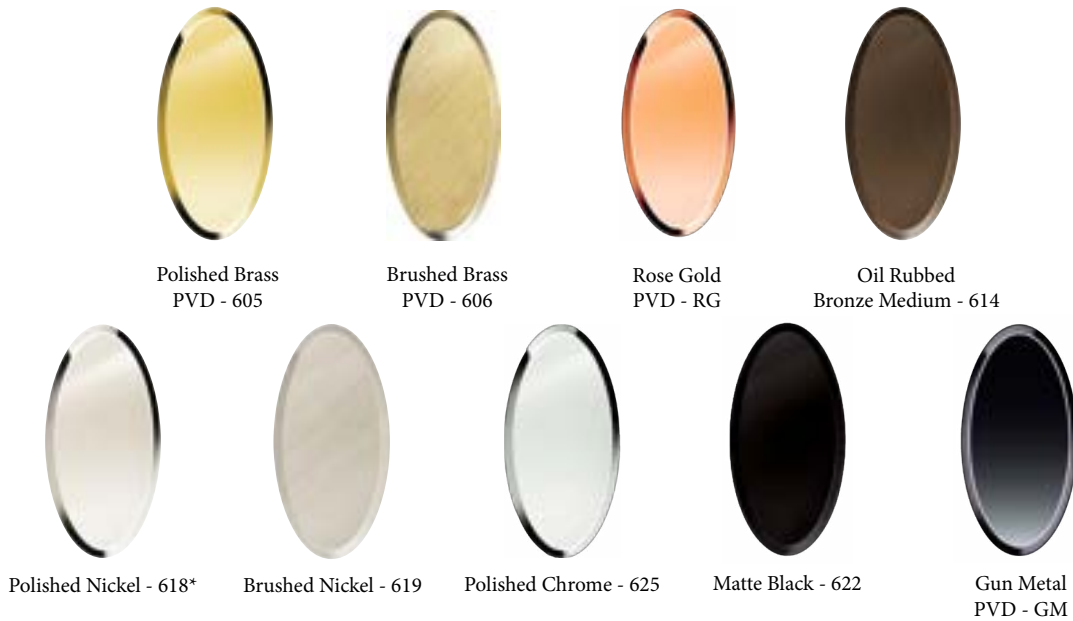

Our wide array of stocked finishes resist tarnishing*, corrosion, and the daily wear that would quickly degrade standard residential-grade finishes. This means our hardware looks as good on day 1,000 as it did on installation day.

Please note that not all items are available in all finishes. Please see Suites for available stocked finishes.

**Polished nickel - an unlacquered and reactive finish - may discolor due to chemical reactions with environmental factors, especially without proper installation and maintenance.*



The Portals Commitment

Lifetime Warranty

Our ability to control the manufacturing process allows us to offer the strongest residential warranty in the industry.

Uncompromising Value

We specialize in crafting premium bathroom fixtures that deliver exceptional quality and sophisticated design at unmatched value.

Outstanding Service

Ordered today, shipped today. More than 95% of all orders placed before 3pm CST will ship the same day. Our team is always available to help you understand our products or help you determine what glass can do in your location.



Elevate Every Space with Custom Glass Shower Hardware

When your design demands more than standard solutions, we deliver the extraordinary.

As your premier partner for custom glass shower hardware, we can transform architectural visions into reality.

Whether you're crafting the signature bathrooms of a luxury resort, designing coherent aesthetics across hundreds of residential units, or creating memorable commercial environments, your hardware should amplify your design intent, not compromise it.



Custom bathroom hardware by Portals Hardware for the Conrad Hotel in New York, NY.



Custom bathroom hardware by Portals Hardware for the International Barclay in New York, NY.

**Call
816.942.7413**
to discuss how
custom glass
shower
hardware can
elevate your
next project.

What Makes Portals' Hinges Unique?

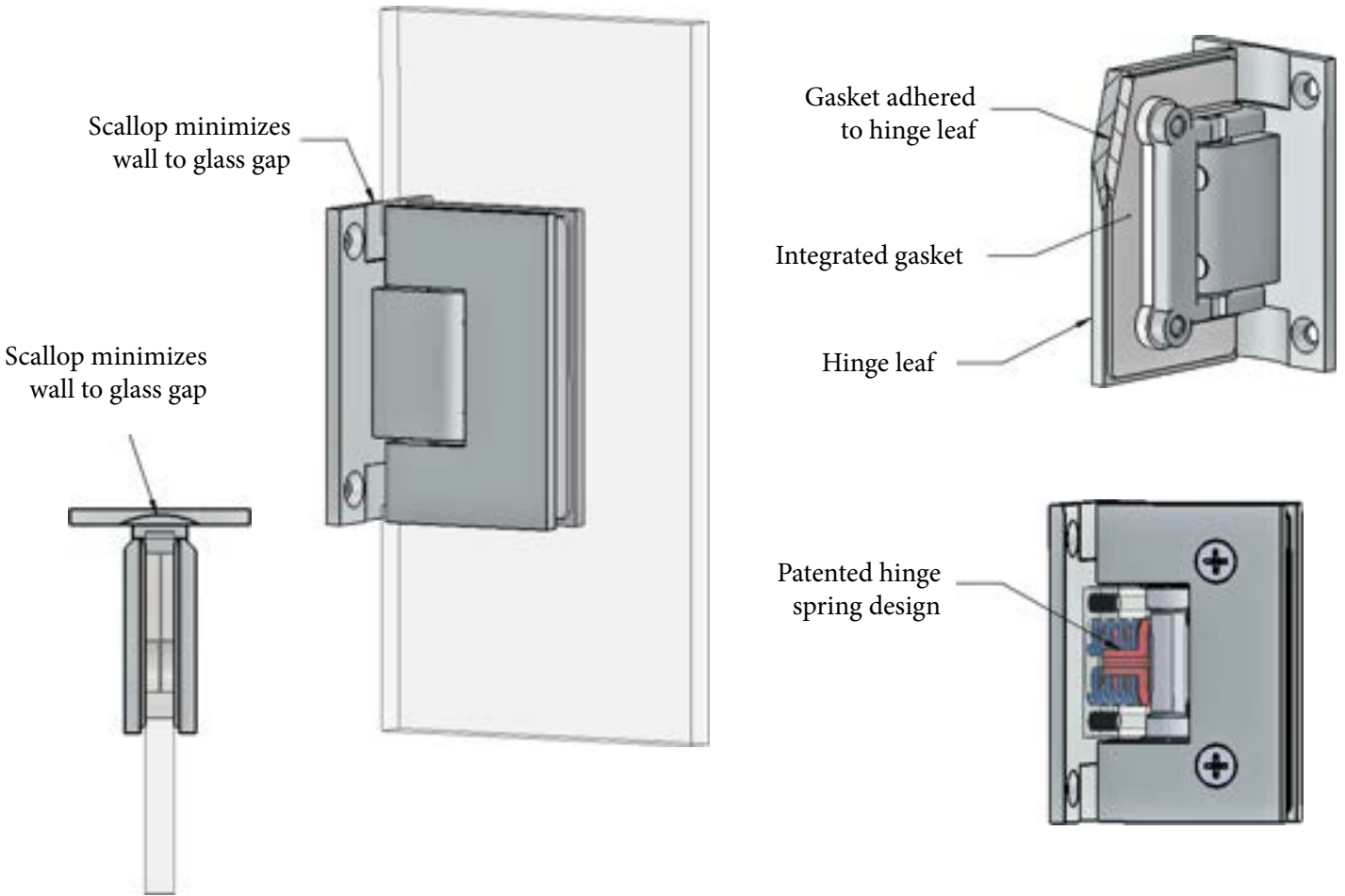

Door Size Specifications for Portals Hinges

<u>Hinge Specifications</u>	<u>Standard Duty</u>		<u>Heavy Duty</u>		<u>Ultra Heavy Duty</u>	<u>Standard Duty Pivot</u>	<u>Heavy Duty Pivot</u>
	2 Hinges	3 Hinges	2 Hinges	3 Hinges	2 Hinges	2 Hinges	2 Hinges
Max. Door Width:	28"	32"	36"	36"	40"	32"	36"
Max. Door Weight:	90 lbs.	120 lbs.	120 lbs.	150 lbs.	160 lbs.	110 lbs.	145 lbs.
Max. Weight/ Top Hinge:	45 lbs. max	45 lbs. max	55 lbs. max	55 lbs. max	80 lbs. max	N/A	N/A
Max. Weight/Bot. Hinge:	N/A		N/A		N/A	110 lbs.	145 lbs.
Glass Thickness:	3/8" to 1/2"		3/8" to 1/2"		3/8" to 1/2"	3/8" to 1/2"	1/2"

Formula to Determine Weight of Glass Door:

Determine Sq. Ft.: (width x height = sq. inches) (divide sq. inches by 144 = sq.ft)

Determine Door Weight: (mutiply sq. ft. x weight/sq. ft. = weight of glass)

3/8" glass = 5.05 lbs./sq.ft.

1/2" glass = 6.40 lbs./sq.ft

Taiga

Standard Duty Hinges



TAG81141/TAG81041*
90° Wall/Glass Hinge

TAG81148/TAG81048*
90° Wall/Glass Hinge
Short Back Plate



TAG81144/TAG81044*
180° Glass/Glass Hinge



TAG81146/TAG81046*
90° Wall/Glass Hinge
Offset Back Plate

Heavy Duty Hinges



TAG81171/TAG81071*
90° Wall/Glass Hinge

TAG81174/TAG81074*
180° Glass/Glass Hinge



TAG81175/TAG81075*
90° Wall/Glass Hinge
Short Back Plate



TAG81173/TAG81073*
135° Neo-Angle Glass/
Glass Hinge



TAG81176/TAG81076*
90° Wall/Glass Hinge
Offset Back Plate



Taiga Hinges Stock Finishes

- Polished Brass PVD - 605
- Brushed Brass PVD - 606
- Oil Rubbed Bronze Medium - 614
- Polished Nickel - 618
- Brushed Nickel - 619
- Matte Black - 622
- Polished Chrome - 625

* Hinges available with a 5° preset to allow tighter shower door closure

Taiga

Standard Duty Adjustable Hinges

TAG81147
Adjustable 90°
Wall/Glass Hinge



TAG81149
Adjustable 90° Wall/Glass Hinge
Offset Back Plate



00414
Adjustable 180°
Glass/Glass Hinge

Heavy Duty Adjustable Hinges

TAG81178
Adjustable 90°
Wall/Glass Hinge



TAG81180
Adjustable 180°
Glass/Glass Hinge



TAG81179
Adjustable 135° Neo-Angle
Glass/Glass Hinge



TAG81181
Adjustable 90° Wall/Glass Hinge
Offset Back Plate



Taiga Hinges Stock Finishes

- Polished Brass PVD - 605
- Brushed Brass PVD - 606
- Oil Rubbed Bronze Medium - 614
- Polished Nickel - 618
- Brushed Nickel - 619
- Matte Black - 622
- Polished Chrome - 625

Taiga

Ultra Heavy Duty Hinges



TAG81201
Adjustable 90° Wall/Glass Hinge



TAG81202
Adjustable 90° Wall/Glass Hinge
Offset Back Plate

Standard Duty Pivot Hinges



TAG81161
Standard Pivot Hinge
Top or Bottom Mount



TAG81162
Pivot Hinge w/Non-Handed
Horizontal Wall Bracket



TAG81163
Pivot Hinge w/Non-Handed
Vertical Wall Bracket



TAG81164
Pivot Hinge w/Non-Handed
Standard Bracket for Header



TAG81165
Pivot Hinge w/Non-Handed
Adjustable Bracket for Header



Heavy Duty Pivot Hinge

TAG81191
Top or Bottom Mount

TAG81194
With Standard Bracket for Header

TAG81195
With Adjustable Bracket for Header

Taiga Hinges Stock Finishes

- Polished Brass PVD - 605
- Brushed Brass PVD - 606
- Oil Rubbed Bronze Medium - 614
- Polished Nickel - 618
- Brushed Nickel - 619
- Matte Black - 622
- Polished Chrome - 625

Taiga

Clamps

00307
Heavy Duty
90° Wall/Glass Clamp



00308
90° Glass/Glass
Inside Square Clamp



00305
Wall/Glass Clamp



00306
90° Glass/Glass
Outside Square Clamp



TAG81153
135° Glass/Glass Clamp



00303
90° Wall/Glass Clamp
with Leg



TAG81351
Wall/Glass Clamp with
Rounded Corners



TAG81154
180° Glass/Glass Clamp

TAG81352
Wall/Glass Clamp with Rounded
Corners - for 1/2" Glass



Operable Transom Clamps



00301
Wall/Glass Operable
Transom Clamp

00302
Glass/Glass Operable
Transom Clamp



Taiga Clamp Stock Finishes

- Polished Brass PVD - 605
- Brushed Brass PVD - 606
- Oil Rubbed Bronze Medium - 614
- Polished Nickel - 618
- Brushed Nickel - 619
- Matte Black - 622
- Polished Chrome - 625

Oceana

Standard Duty Hinges



OCN80141/OCN80041*
90° Wall/Glass Beveled Hinge

OCN80146/OCN80046*
90° Wall/Glass Beveled Hinge
Offset Back Plate



OCN80144/OCN80044*
180° Glass/Glass
Beveled Hinge



OCN80145/OCN80045*
90° Wall/Glass Beveled Hinge Short
back plate



Heavy Duty Hinges



OCN80171/OCN80071*
90° Wall/Glass Beveled Hinge

OCN80175/OCN80075*
90° Wall/Glass Beveled Hinge
Short Back Plate



OCN80176/OCN80076*
90° Wall/Glass Beveled Hinge
Offset Back Plate



OCN80173/OCN80073*
135° Neo-Angle Glass/Glass Beveled Hinge

OCN80174/OCN80074*
180° Glass/Glass Beveled Hinge

● Brushed Brass PVD - 606

● Oil Rubbed Bronze Medium - 614

● Polished Nickel - 618

● Brushed Nickel - 619

● Matte Black - 622

● Polished Chrome - 625

* Hinges available with a 5° preset to allow tighter shower door closure

Oceana

Standard Duty Adjustable Hinges

OCN80148
Adjustable 135° NeoAngle Glass/
Glass Beveled Hinge



OCN80149
Adjustable 90° Wall/Glass Beveled Hinge
Offset Back Plate



OCN80147
Adjustable 90° Wall/Glass
Beveled Hinge



00464
Adjustable 180° Glass/Glass
Beveled Hinge



Heavy Duty Adjustable Hinges



OCN80179
Adjustable 135° Neo-Angle
Glass/Glass Beveled Hinge

OCN80180
Adjustable 180° Glass/Glass
Beveled Hinge



OCN80178
Adjustable 90° Wall/Glass
Beveled Hinge



OCN80181
Adjustable 90° Wall/Glass Beveled
Hinge Offset Back Plate



Oceana Hinge Stock Finishes

● Brushed Brass PVD - 606

● Oil Rubbed Bronze Medium - 614

● Polished Nickel - 618

● Brushed Nickel - 619

● Matte Black - 622

● Polished Chrome - 625



Standard Duty Pivot Hinges

Standard Pivot Hinge
Top or Bottom Mount
OCN80161



OCN80162
Pivot Hinge w/Non-Handed
Horizontal Wall Bracket



OCN80163
Pivot Hinge w/Non-Handed
Vertical Wall Bracket



OCN80164
Pivot Hinge w/Non-Handed
Standard Bracket for Header



OCN80165
Pivot Hinge w/Non-Handed
Adjustable Bracket for Header



OCN80166
Pivot Hinge with Clamp Assembly (Bot-
tom Left or Top Right)

OCN80167
(Bottom Right or Top Left)



Heavy Duty Pivot Hinge

OCN80191
Top or Bottom Mount



OCN80194
With Standard Bracket for Header

OCN80195
With Adjustable Bracket for Header

Oceana Hinge Stock Finishes



Brushed Brass PVD - 606



Oil Rubbed Bronze Medium - 614



Polished Nickel - 618



Brushed Nickel - 619



Matte Black - 622



Polished Chrome - 625

Oceana

Clamps



00357
Heavy Duty 90° Wall/Glass
Beveled Clamp



00356
Outside 90° Glass/Glass
Beveled Clamp

00355
Wall/Glass
Beveled Clamp



OCN80153
135° Glass/Glass Beveled Clamp

OCN80154
180° Glass/Glass Beveled Clamp



Operable Transom Clamps

00351
Wall/Glass Operable
Beveled Transom Clamp



00352
Glass/Glass Operable
Beveled Transom Clamp



Oceana Clamp Stock Finishes

● Brushed Brass PVD - 606

● Oil Rubbed Bronze Medium - 614

● Polished Nickel - 618

● Brushed Nickel - 619

● Matte Black - 622

● Polished Chrome - 625

Symphony

Standard Duty Hinges



L.10.141 / L.10.141-85*
90° Wall/Glass Hinge



L.10.146 / L.10.146-85*
90° Wall/Glass Hinge
(Offset Back Plate)



L.10.145 / L.10.145-85*
90° Glass/Glass Hinge



L.10.144 / L.10.144B*
180° Glass/Glass Hinge



L.10.143 / L.10.143B*
135° Glass/Glass Hinge

Heavy Duty Hinges



L.10.171 / L.10.171-85*
90° Wall/Glass Hinge



L.10.176 / L.10.176-85*
90° Wall/Glass Hinge
(Offset Back Plate)



L.10.173 / L.10.173B*
135° Glass/Glass Hinge



L.10.174 / L.10.174B*
180° Glass/Glass Hinge

Symphony Hinge Stock Finishes

- Polished Brass PVD - 605
- Brushed Brass PVD - 606
- Rose Gold PVD - RG**
- Oil Rubbed Bronze Medium - 614
- Polished Nickel - 618
- Brushed Nickel - 619
- Polished Chrome - 625
- Matte Black - 622
- Gun Metal PVD - GM**

* Hinges available with a 5° preset to allow tighter shower door closure

**Only available for heavy duty

Symphony

Standard Duty Pivot Hinges



L.10.162/L.10.162-85*
Pivot Hinge w/Non-Handed
Horizontal Wall Bracket



L.10.163/L.10.163-85*
Pivot Hinge w/Non-Handed
Vertical Wall Mount



L.10.161/L.10.161-85*
Standard Duty Pivot Hinge
Top or Bottom Mount

If ordering a Pivot Hinge with available 5° preset, please advise handing of door, hinges on left or hinges on right when facing shower.



L.10.167/L.10.167-85*
Standard Duty Pivot Hinge w/Clamp for
Bottom Right or Top Left



L.10.166/L.10.166-85*
Standard Duty Pivot Hinge w/Clamp for
Bottom Left or Top Right









L.10.164/L.10.164-85*
Pivot Hinge w/Non-Handed
Standard Bracket for Header



L.10.165/L.10.165-85*
Pivot Hinge w/Non-Handed
Adjustable Bracket for Header

Symphony Pivot Hinge Stock Finishes

-  Polished Brass PVD - 605
-  Brushed Brass PVD - 606
-  Polished Chrome - 625
-  Oil Rubbed Bronze Medium - 614
-  Polished Nickel - 618
-  Brushed Nickel - 619
-  Matte Black - 622

Symphony

Clamps



L.10.151
Wall/Glass Clamp



L.10.158
90° Inside Glass/Glass Clamp



L.10.159
90° Heavy Duty Wall/Glass Clamp



L.10.152
90° Outside Glass/Glass Clamp



L.10.153
135° Glass/Glass Clamp



L.10.157
90° Wall/Glass Clamp with Leg



L.10.154
180° Glass/Glass Clamp

Operable Transom Clamps



L.10.155
Wall/Glass Transom Clamp



L.10.156
Glass/Glass Transom Clamp

Symphony Clamp Stock Finishes

- Polished Brass PVD - 605
- Brushed Brass PVD - 606
- Rose Gold PVD - RG**
- Oil Rubbed Bronze Medium - 614
- Polished Nickel - 618
- Brushed Nickel - 619
- Polished Chrome - 625
- Matte Black - 622
- Gun Metal PVD - GM**

**Only available for 90° clamps

Concerto

Standard Duty Hinges



L.30.141/L.30.141-85*
90° Wall/Glass Hinge

L.30.146/L.30.146-85*
90° Wall/Glass Hinge
(Offset Back Plate)



L.30.144/L.30.144B*
180° Glass/Glass Hinge



L.30.143/L.30.143B*
135° Glass/Glass Hinge

Heavy Duty Hinges



L.30.176/L.30.176-85*
90° Wall/Glass Hinge
(Offset Back Plate)

L.30.171/L.30.171-85*
90° Wall/Glass Hinge



L.30.173/L.30.173B*
135° Glass/Glass Hinge



L.30.174/L.30.174B*
180° Glass/Glass Hinge

Concerto Hinge Stock Finishes

- Rose Gold PVD - RG**
- Oil Rubbed Bronze Medium - 614
- Polished Nickel - 618
- Brushed Nickel - 619
- Gun Metal PVD - GM**
- Matte Black - 622
- Polished Chrome - 625

* Hinges available with a 5° preset to allow tighter shower door closure

**Only available for heavy duty

Concerto

Standard Duty Pivot Hinges



L.30.161
Standard Pivot Hinge
Top or Bottom Mount



L.30.162
Pivot Hinge w/Non-Handed
Horizontal Wall Bracket



L.30.163
Pivot Hinge w/Non-Handed
Vertical Wall Mount



L.30.164
Pivot Hinge w/Non-Handed
Standard Bracket for Header



L.30.165
Pivot Hinge w/Non-Handed
Adjustable Bracket for Header

Concerto Pivot Hinge Stock Finishes

- Oil Rubbed Bronze Medium - 614
- Polished Nickel - 618
- Brushed Nickel - 619
- Matte Black - 622
- Polished Chrome - 625

Concerto

Clamps



L.30.151
90° Wall/Glass Clamp



L.30.153
135° Glass/Glass Clamp



L.30.157
90° Wall/Glass Clamp w. Leg



L.30.152
90° Glass/Glass Clamp



L.30.158
90° Glass/Glass Clamp



L.30.154
180° Glass/Glass Clamp



L.30.159
90° Heavy Duty Wall/Glass Clamp

Operable Transom Clamps



L.30.155
Wall/Glass Transom Clamp



L.30.156
Glass/Glass Transom Clamp

Concerto Clamp Stock Finishes



Rose Gold PVD - RG**



Oil Rubbed Bronze Medium - 614



Polished Nickel - 618



Brushed Nickel - 619



Gun Metal PVD - GM**



Matte Black - 622



Polished Chrome - 625

Sleeve Over Structural System

(No Holes Required)



TAG81350
3/8" Mini Channel
00320
1/2" Mini Channel



00321
90° Sleeve Over Corner
Glass Clamp (3/8")



00322
180° Sleeve Over
Glass Clamp (3/8")



00325
90° Right Hand Inside
Sleeve Over Corner Clamp (3/8")



TAG81325
135° Sleeve Over Glass Clamp (3/8")



00324
90° Left Hand Inside
Sleeve Over Corner Clamp (3/8")



TAG81326
Adjustable Sleeve Over Glass Clamp (3/8")

Sleeve Over Finishes



Polished Brass PVD - 605



Brushed Brass PVD - 606



Oil Rubbed Bronze Medium - 614



Polished Nickel - 618



Brushed Nickel - 619



Matte Black - 622



Polished Chrome - 625

Aria

Suite



L.32.134 24" c/c Single Towel Bar



L.32.112 6" c/c Double Pull
L.32.114 8" c/c Double Pull



L.32.135 24" c/c Double Towel Bar



L.32.111 6" c/c Single Pull
L.32.113 8" c/c Single Pull



L.32.129 Double Hook

Aria : A flowing, modern design for the modern bathroom



L.32.128 Single Hook

Aria Finishes

- Oil Rubbed Bronze Medium - 614
- Polished Nickel - 618
- Brushed Nickel - 619
- Polished Chrome - 625

Taiga Suite

TAG81128 Single Square Robe Hook



00204 6" c/c Double Square Pull
00205 8" c/c Double Square Pull



TAG81131 18" c/c Double Square Towel Bar
TAG81135 24" c/c Double Square Towel Bar



TAG81115 18" Towel Bar x 6" Pull
TAG81116 18" Towel Bar x 8" Pull



TAG81117 24" Towel Bar x 6" Pull
TAG81118 24" Towel Bar x 8" Pull

00706 18" c/c Single Square Towel Bar
00707 24" c/c Single Square Towel Bar



Taiga Finishes

- Brushed Brass PVD - 606
- Oil Rubbed Bronze Medium - 614
- Polished Nickel - 618
- Brushed Nickel - 619
- Matte Black - 622
- Polished Chrome - 625

Oceana Suite



00209 6" c/c Double Pull
00210 8" c/c Double Pull

OCN80124 Double Knob No Sleeve



OCN80123 Single Knob No Sleeve



00211 6" c/c Double Pull w. Rosettes
00212 8" c/c Double Pull w. Rosettes

OCN80128 Single Robe Hook



00501 Single Knob with Sleeve

Towel Bar x Pull without Rosettes

00807 18" c/c Towel Bar x 6" Pull
00805 24" c/c Towel Bar x 6" Pull
00803 18" c/c Towel Bar x 8" Pull
00804 24" c/c Towel Bar x 8" Pull



Double Knob with Sleeve 00502



Oceana Finishes

- Brushed Brass PVD - 606
- Oil Rubbed Bronze Medium - 614
- Polished Nickel - 618
- Brushed Nickel - 619
- Matte Black - 622
- Polished Chrome - 625

Towel Bar x Pull with Rosettes

- 00813 18" c/c Towel Bar x 6" Pull
- OCN80206 20" c/c Towel Bar x 6" Pull
- OCN80226 22" c/c Towel Bar x 6" Pull
- 00814 24" c/c Towel Bar x 6" Pull
- 00817 18" c/c Towel Bar x 8" Pull
- OCN80208 20" c/c Towel Bar x 8" Pull
- OCN80228 22" c/c Towel Bar x 8" Pull
- 00815 24" c/c Towel Bar x 8" Pull



Single Towel Bar without Rosettes

- 00701 18" c/c Single Towel Bar
- OCN80132 20" c/c Single Towel Bar
- OCN80133 22" c/c Single Towel Bar
- 00702 24" c/c Single Towel Bar



- 00714 18" c/c Double Towel Bar w. Rosettes
- 00715 24" c/c Double Towel Bar w. Rosettes

Single Towel Bar with Rosettes

- 00711 18" c/c Single Towel Bar
- OCN80032 20" c/c Single Towel Bar
- OCN80033 22" c/c Single Towel Bar
- 00712 24" c/c Single Towel Bar

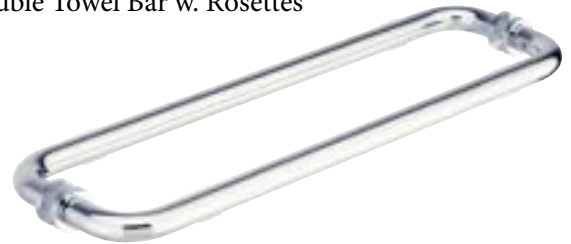

- 00704 18" c/c Double Towel Bar
- 00705 24" c/c Double Towel Bar

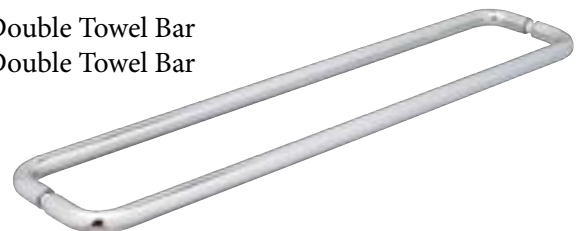

Symphony Suite

9/16"
Diameter
Cutttable Bar

L.10.134 24" c/c Single Towel Bar

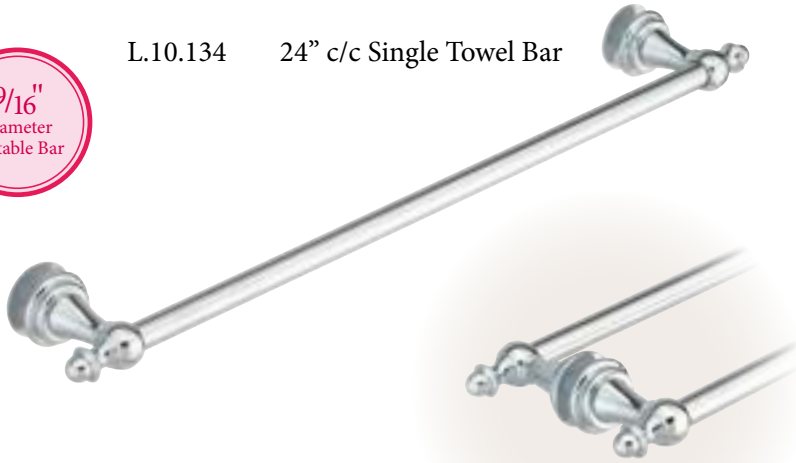

L.10.135 24" c/c Double Towel Bar

Photo courtesy of Hudson Glass & Mirror,
8524 Olde Eight Rd, Northfield OH 44067



L.10.112 6" c/c Double Pull

L.10.114 8" c/c Double Pull

L.10.111 6" c/c Single Pull

L.10.113 8" c/c Single Pull



L.10.117 24" c/c Towel Bar x 6" c/c Pull

L.10.118 24" c/c Towel Bar x 8" c/c Pull



Symphony Finishes

- Polished Brass PVD - 605
- Brushed Brass PVD - 606
- Rose Gold PVD - RG
- Gun Metal PVD - GM
- Oil Rubbed Bronze Medium - 614
- Polished Nickel - 618
- Brushed Nickel - 619
- Matte Black - 622
- Polished Chrome - 625



L.10.129 Double Hook



L.10.122 Double Knob



L.10.128 Single Hook



L.10.121 Single Knob



Photo courtesy of Haider Glass Specialties,
1717 Commerce Dr, Ste A, Bismarck ND, 58501

Symphony
Wall-Mounted Hardware
COMING SOON



L.11.117 24" c/c Towel Bar x 6" c/c Pull
L.11.118 24" c/c Towel Bar x 8" c/c Pull



L.11.112 6" c/c Double Pull
L.11.114 8" c/c Double Pull
L.11.114-12 12" c/c Double Pull



L.11.111 6" c/c Single Pull
L.11.113 8" c/c Single Pull

L.11.134 24" c/c Single Towel Bar

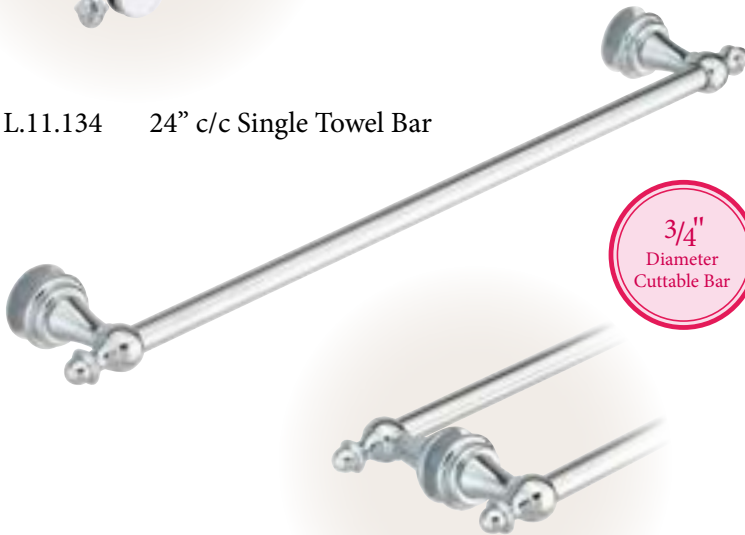

3/4"
Diameter
Cutttable Bar

9/16" & 3/4"
Diameter
Cutttable Bar

L.11.135 24" c/c Double Towel Bar



L.10.125 24" c/c Towel Bar x Knob
L.11.125 24" c/c Towel Bar x Knob

Symphony: a colonial design complementing most traditional bathrooms



Photo courtesy of Quality Glass & Mirror,
532D Hampton Hwy, Yorktown, VA 23693

L.30.112 6" c/c Double Pull

L.30.114 8" c/c Double Pull

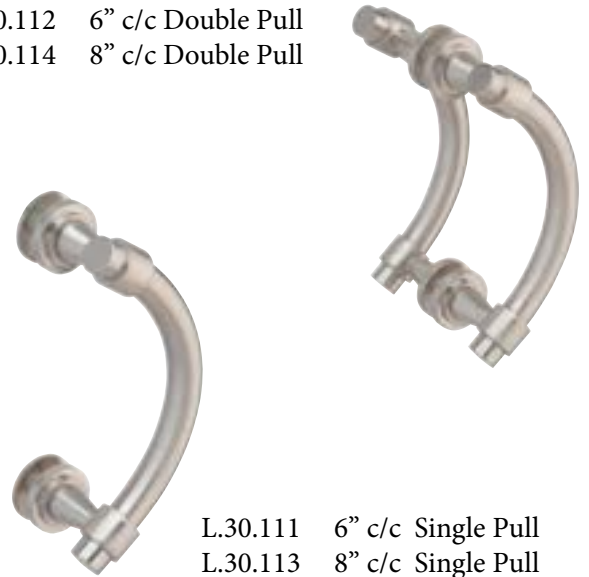

L.30.111 6" c/c Single Pull

L.30.113 8" c/c Single Pull

Concerto Suite

L.30.125 24" c/c Towel Bar x Knob



L.30.117 24" c/c Towel Bar x 6" c/c Pull

L.30.118 24" c/c Towel Bar x 8" c/c Pull



L.30.128 Single Hook



L.30.129 Double Hook

Concerto: A modern design with a European flair



L.30.121 Single Knob



L.30.122 Double Knob

L.31.111 6" c/c Single Pull

L.31.113 8" c/c Single Pull



L.31.112 6" c/c Double Pull

L.31.114 8" c/c Double Pull

L.31.114-12 12" c/c Double Pull



L.31.117 24" c/c Towel Bar x 6" c/c Pull

L.31.118 24" c/c Towel Bar x 8" c/c Pull



L.30.135 24" c/c Double Towel Bar

L.30.134 24" c/c Single Towel Bar



NEW Wall-Mounted Concerto

Concerto Finishes

-  Rose Gold PVD - RG
-  Gun Metal PVD - GM
-  Oil Rubbed Bronze Medium - 614
-  Polished Nickel - 618
-  Brushed Nickel - 619
-  Matte Black - 622
-  Polished Chrome - 625







Wall-Mounted Grab Bars

EVO24CON 24" c/c Wall-Mounted Grab Bar

Sonata

Suite

Sonata Finishes

-  Polished Brass PVD - 605
-  Polished Nickel - 618
-  Brushed Nickel - 619
-  Matte Black - 622
-  Polished Chrome - 625



L.22.111 6" c/c Single Pull
L.22.113 8" c/c Single Pull



L.21.111 6" c/c Single Pull
L.21.113 8" c/c Single Pull



L.22.121 Single Knob



L.22.112 6" c/c Double Pull
L.22.114 8" c/c Double Pull



L.22.122 Double Knob



L.21.112 6" c/c Double Pull
L.21.114 8" c/c Double Pull



L.22.129 Double Hook



L.22.128 Single Hook

Sonata : A decorative design with intricate scrollwork elements supporting classic bathrooms

L.21.135 24" c/c Double Towel Bar



3/4"
Diameter
Cutttable Bar



L.21.134 24" c/c Single Towel Bar

L.21.125 24" c/c Towel Bar x Knob









L.21.117 24" c/c Towel Bar x 6" c/c Pull

L.21.118 24" c/c Towel Bar x 8" c/c Pull



Opus Suite

L.40: Includes Rosettes

- Opus Finishes**
-  Polished Brass PVD - 605
 -  Oil Rubbed Bronze Medium - 614
 -  Polished Nickel - 618
 -  Brushed Nickel - 619
 -  Matte Black - 622
 -  Polished Chrome - 625



L.40.125 24" c/c Towel Bar x Knob



L.40.135 24" c/c Double Towel Bar



L.40.134 24" c/c Single Towel Bar



L.40.117 24" c/c Towel Bar x 6" c/c Pull

L.40.118 24" c/c Towel Bar x 8" c/c Pull

Photo courtesy of Hudson Glass & Mirror,
8524 Olde Eight Rd, Northfield OH 44067



L.40.111 6" c/c Single Pull

L.40.113 8" c/c Single Pull



L.40.121 Single Knob



L.40.122 Double Knob



L.40.129 Double Hook



L.40.128 Single Hook

Opus : the classic tubular shower door series, with or without style washers, available with cuttable towel bars

Opus Suite

L.41: Without Rosettes

L.41.128 Single Hook



L.41.134 24" c/c Single Towel Bar



L.41.129 Double Hook



L.41.111 6" c/c Single Pull

L.41.113 8" c/c Single Pull

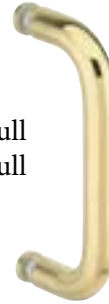

L.41.121 Single Knob



L.41.117 24" c/c Towel Bar x 6" c/c Pull

L.41.118 24" c/c Towel Bar x 8" c/c Pull



L.41.122 Double Knob



L.41.135 24" c/c Double Towel Bar

Opus Solid

OPS40304 8" Solid Double Pull 1" Diameter



L.41.125 24" c/c Towel Bar x Knob



OPS40202 6" Solid Double Pull

OPS40204 8" Solid Double Pull

Coda Suite



Photo courtesy of Haider Glass Specialties
Bismarck, ND 58501

- L.70.111 6" c/c Single Pull
- L.70.113 8" c/c Single Pull



- L.70.112 6" c/c Double Pull
- L.70.114 8" c/c Double Pull



- L.70.130 18" c/c Single Towel Bar
- L.70.134 24" c/c Single Towel Bar



- COD70115 18" c/c Towel Bar x 6" Pull
- COD70116 18" c/c Towel Bar x 8" Pull
- COD70117 24" c/c Towel Bar x 6" Pull
- COD70118 24" c/c Towel Bar x 8" Pull



- L.70.131 18" c/c Double Towel Bar
- L.70.135 24" c/c Double Towel Bar

Coda : modern industrial
meets classic style

L.70.120 Double Hook



L.70.128 Single Hook







L.70.122 Double Knob



L.70.121 Single Knob



Coda Finishes

-  Brushed Brass PVD - 606
-  Oil Rubbed Bronze Medium - 614
-  Polished Nickel - 618
-  Brushed Nickel - 619
-  Matte Black - 622
-  Polished Chrome - 625

NEW Wall-Mounted Coda

Wall-Mounted Grab Bar

EVO24COD.CH Wall-Mounted Grab Bar



Wall-Mounted Hook

COD70105 Wall-Mounted Hook



Wall-Mounted Towel Bars

COD70107 18" c/c Wall-Mounted Towel Bar

COD70106 24" c/c Wall-Mounted Towel Bar



Counterpoint L.45: Without Rosettes Suite



L.45.122 Double Knob



L.45.121 Single Knob

Add 4" to c/c measurement for overall pull length

- L.45.112 6" c/c Double Pull
- L.45.114 8" c/c Double Pull



- L.45.111 6" c/c Single Pull
- L.45.113 8" c/c Single Pull



- L.45.124 18" c/c Towel Bar x Knob
- L.45.125 24" c/c Towel Bar x Knob



- ### Counterpoint Finishes
-  Polished Brass PVD - 605
 -  Brushed Brass PVD - 606
 -  Oil Rubbed Bronze Medium - 614
 -  Polished Nickel - 618
 -  Brushed Nickel - 619
 -  Matte Black - 622
 -  Polished Chrome - 625
 -  Brushed Stainless - 630



L.45.128 Single Hook



L.45.129 Double Hook

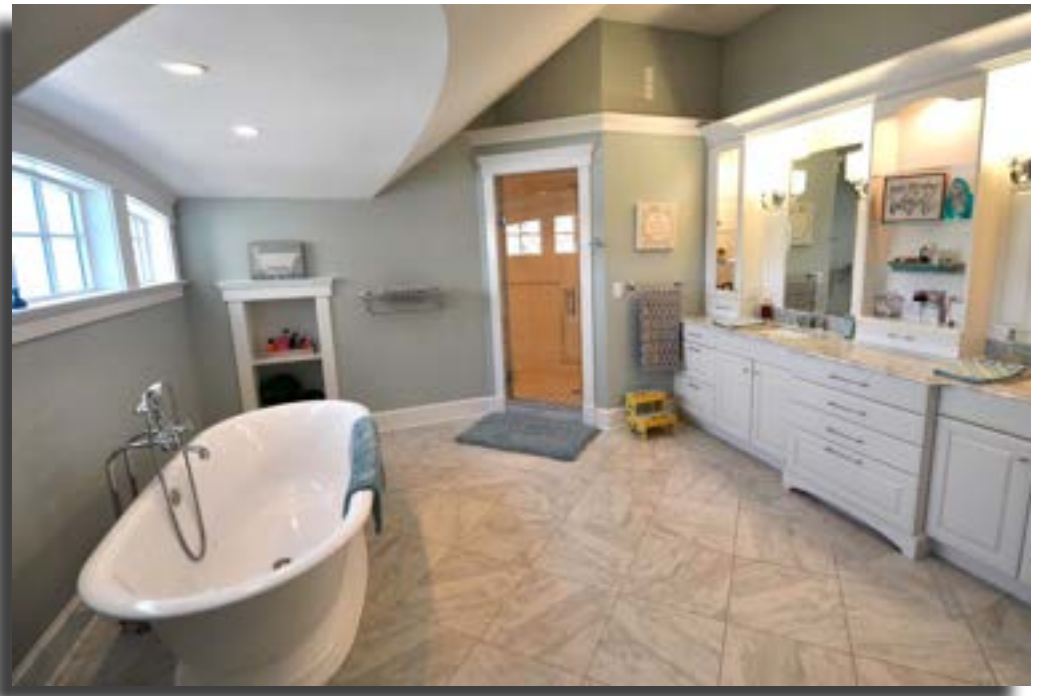
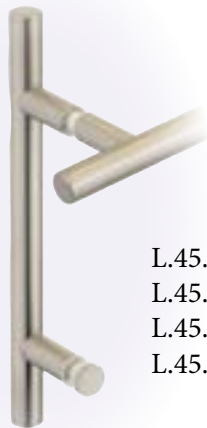

Photo courtesy of Plymouth Glass and Mirror,
142 E Main St, Thomaston, CT 06787



- L.45.115 18" c/c Towel Bar x 6" c/c Pull
- L.45.116 18" c/c Towel Bar x 8" c/c Pull
- L.45.117 24" c/c Towel Bar x 6" c/c Pull
- L.45.118 24" c/c Towel Bar x 8" c/c Pull

- L.45.130 18" c/c Single Towel Bar
- L.45.134 24" c/c Single Towel Bar



- L.45.114-12 12" c/c Double Pull
- L.45.114-18 18" c/c Double Pull

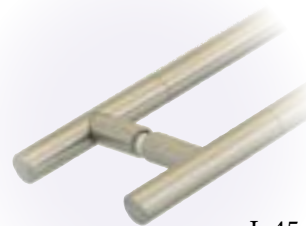

- L.45.131 18" c/c Double Towel Bar
- L.45.135 24" c/c Double Towel Bar

Counterpoint: Cylindrical minimalism meets modern minimalism

Counterpoint L.46: Includes Rosettes Suite

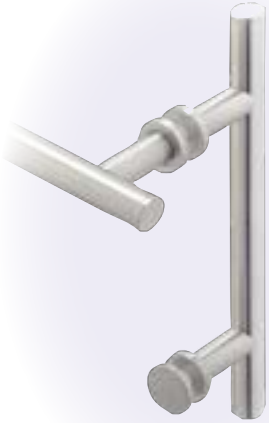

- L.46.115 18" c/c Towel Bar x 6" c/c Pull
- L.46.116 18" c/c Towel Bar x 8" c/c Pull
- L.46.117 24" c/c Towel Bar x 6" c/c Pull
- L.46.118 24" c/c Towel Bar x 8" c/c Pull



L.46.128 Single Hook



L.46.129 Double Hook

NEW Wall-Mounted Counterpoint

Wall-Mounted Hook

CTP46105 Wall-Mounted Hook



Wall-Mounted Towel Bars

CTP46107 18" c/c Wall-Mounted Towel Bar
CTP46106 24" c/c Wall-Mounted Towel Bar

Add 3" to c/c measurement for overall towel bar length



L.46.124 18" c/c Towel Bar x Knob
L.46.125 24" c/c Towel Bar x Knob

Counterpoint Finishes

- Polished Brass PVD - 605
- Brushed Brass PVD - 606
- Oil Rubbed Bronze Medium - 614
- Polished Nickel - 618
- Brushed Nickel - 619
- Matte Black - 622
- Polished Chrome - 625



Photo courtesy of Haider Glass Specialties,
1717 Commerce Dr, Ste A, Bismarck ND, 58501



L.46.111 6" c/c Single Pull
L.46.113 8" c/c Single Pull



L.46.112 6" c/c Double Pull
L.46.114 8" c/c Double Pull

Add 4" to c/c
measurement for overall
pull length



L.46.121 Single Knob



L.46.122 Double Knob



L.46.114-12 12" c/c Double Pull
L.46.114-18 18" c/c Double Pull



L.46.130 18" c/c Single Towel Bar
L.46.134 24" c/c Single Towel Bar

Add 3" to c/c
measurement for overall
towel bar length

3/4"
Diameter
Bar



L.46.131 18" c/c Double Towel Bar
L.46.135 24" c/c Double Towel Bar

Counterpoint Suite

Long Pulls



- L.45.213-8 8" c/c Single Pull
- L.45.213-12 12" c/c Single Pull
- L.45.213-18 18" c/c Single Pull
- L.45.213-24 24" c/c Single Pull
- L.45.213-36 36" c/c Single Pull

Add 8" to c/c measurement for overall pull length

- L.45.214-8 8" c/c Double Pull
- L.45.214-12 12" c/c Double Pull
- L.45.214-18 18" c/c Double Pull
- L.45.214-24 24" c/c Double Pull
- L.45.214-36 36" c/c Double Pull*



1" Diameter Bar
NON-CUTTABLE BAR



- L.46.214-8 8" c/c Double Pull
- L.46.214-12 12" c/c Double Pull
- L.46.214-18 18" c/c Double Pull
- L.46.214-24 24" c/c Double Pull
- L.46.214-36 36" c/c Double Pull*

- L.46.213-8 8" c/c Single Pull
- L.46.213-12 12" c/c Single Pull
- L.46.213-18 18" c/c Single Pull
- L.46.213-24 24" c/c Single Pull
- L.46.213-36 36" c/c Single Pull



Photo courtesy of Independent Glass Werx,
10103 Mar Rock Drive, Hagerstown MD 21740

Counterpoint 214 Finishes

-  Oil Rubbed Bronze Medium - 614
-  Brushed Nickel PVD - 619
-  Polished Chrome PVD - 625

*36" Pulls only available in Polished Chrome - 625



Rondo Finishes

-  Polished Brass PVD - 605
-  Oil Rubbed Bronze Medium - 614
-  Polished Nickel - 618
-  Brushed Nickel - 619
-  Matte Black - 622
-  Polished Chrome - 625

- L.50.111 6" c/c Single Pull
- L.50.113 8" c/c Single Pull



Rondo Suite

9/16"
Diameter
Cutttable Bar

- L.50.134 24" c/c Single Towel Bar



- L.50.112 6" c/c Double Pull
- L.50.114 8" c/c Double Pull



- L.50.135 24" c/c Double Towel Bar



- L.50.122 Double Knob



- L.50.121 Single Knob

- L.50.128 Single Hook



- L.50.129 Double Hook



- L.50.125 24" c/c Towel Bar x Knob

- L.50.117 24" c/c Towel Bar x 6" c/c Pull
- L.50.118 24" c/c Towel Bar x 8" c/c Pull



Rondo : An Arts & Crafts style with classic design elements

Products have design and utility patent rights

Overture Suite



L.61.131 18" c/c Double Towel Bar
L.61.135 24" c/c Double Towel Bar



L.61.128 Single Hook

L.61.112 6" c/c Double Pull
L.61.114 8" c/c Double Pull



618, 619, 622, and 625





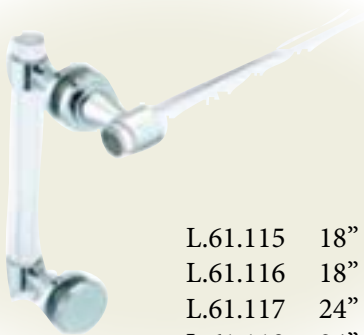

L.61.130 18" c/c Single Towel Bar
L.61.134 24" c/c Single Towel Bar



L.61.115 18" c/c Towel Bar x 6" c/c Pull
L.61.116 18" c/c Towel Bar x 8" c/c Pull
L.61.117 24" c/c Towel Bar x 6" c/c Pull
L.61.118 24" c/c Towel Bar x 8" c/c Pull

Overture Finishes

-  Polished Nickel - 618
-  Brushed Nickel - 619
-  Matte Black - 622
-  Polished Chrome - 625

Bars are Borosilicate Glass (Pyrex™) from the Czech Republic; fabricated in the U.S.

Overture: A modern design made from fine Eastern Europe.

Wipes + Seals

PSM00402PP
Bottom Dual Fin Wipe & Drip Rail For
3/8" Glass - Polycarbonate
94" Long

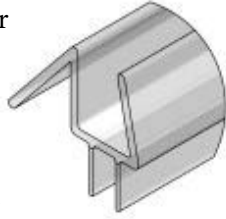

PSM00432PP
Bottom Dual Fin Wipe & Drip Rail for
3/8" Glass - Polycarbonate
36" Long

PSM00420PP
Vinyl Bulb Seal
Polycarbonate & Flex PVC
94" Long



PSM00409PLY
"L" 1/2" x 1/2" Clear Jamb With Pre-Applied Tape
94" Long



PSM00410PP
Dual Fin Wipe for 3/8" Glass - Polycarbonate
94" Long

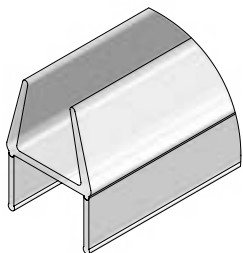

PSM00403PLY
"H" Jamb/Strike for 3/8" Glass
Polycarbonate
94" Long

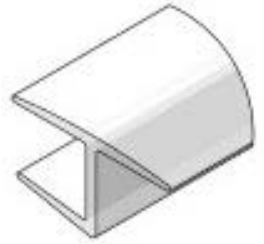

PSM00405PP
"h" Seal/Strike for 3/8" Glass
Polycarbonate & Flex PVC
94" Long

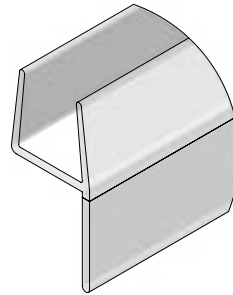

PSM00404PP
Angled Fin Wipe/Seal for 3/8" Glass
Polycarbonate & Flex PVC
94" Long



PSM00406PP
"h" Jamb/Strike with Cushion for 3/8" Glass
Polycarbonate & Flex PVC
94" Long

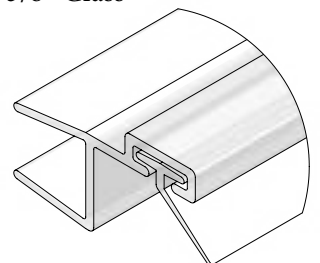

Portals Structural Material

Additional items & finishes being added on an ongoing basis.
Please visit portalshardware.com for current products and finishes available.

U-Channel

Deep 3/8" Glass

PSM00217 94" long
PSM00227 144" long*

Deep 1/2" Glass

PSM00216 94" long



U-Channel Finishes



*144" Channel only available in Brushed Nickel - BN and Brite Anodized - BA

Header

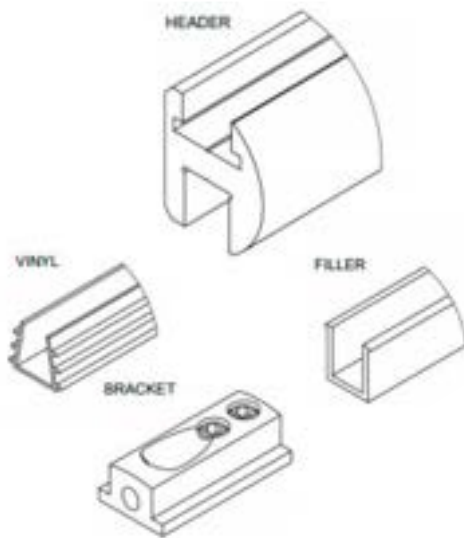

Kit Includes:

- Aluminum Header Extrusion (x1)
- 36" Aluminum Snap-in Filler Insert (x1)
- Vinyl Glazing Insert (x1)
- Brass Wall Brackets & Stainless Steel Set Screws (x2)
- Stainless Steel #10 x 2" Wood Screws

Deluxe Flat/RoundHeader Kit

PSM00101 94" long
PSM00102 66" long

Header Finishes

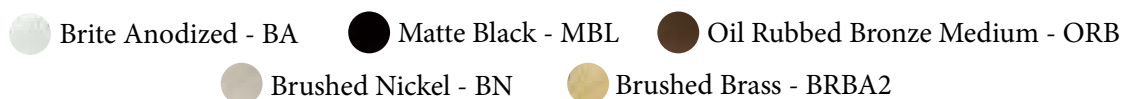

Sliding Shower Door Systems



OCN80620
Sliding Door 90°
Return Glass Adapter



TAG81620
Sliding Door 90°
Return Glass Adapter

OCN80610 Oceana Round Sliding Shower Door System



TAG81610 Taiga Square Sliding Shower Door System

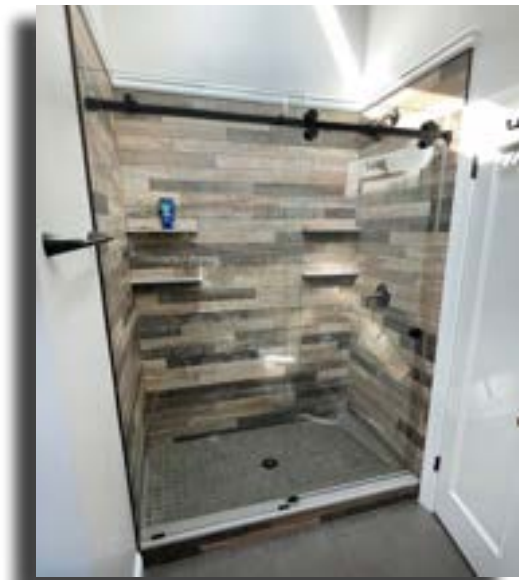

Photo courtesy of Oliveri Architectural Glass,
130 Lenox Ave, Suite #30, Stamford CT, 06906

Sliding System Finishes

- Brushed Brass PVD - 606
- Matte Black - 622
- Polished Satinless Steel - 629
- Brushed Stainless - 630

Support Bars

Support Bar Finishes

- Brushed Nickel - 619
- Matte Black - 622
- Polished Chrome - 625
- Brushed Brass PVD - 606

PSM00510
PSM00511

Wall-Glass Support Bar
Glass-Glass Support Bar



Caring for Your Hardware

Portals Hardware offers a lifetime warranty on most of our glass shower door hardware for residential use, covering defects in material and workmanship. Our retain their beauty for decades with proper installation, care and maintenance.

Shower Enclosure Care & Maintenance

Special care and precautions must be made in order to keep your shower enclosure looking as new as the day it was installed. It is recommended that you rinse and wipe down or squeegee after each use but this may not be a practical solution for most homeowners due to time constraints, etc.

In this case, it is recommended that you use a mild detergent and a soft cloth to clean the shower enclosure every 2-3 weeks. A solution of 50% vinegar and 50% water is a safe and effective solution for most residue left from hard water, humidity, soap and shampoo.

If you choose to use a commercial cleaning solution, please avoid any harsh or abrasive cleaners that may contain ammonia, bleach, oxide or acids or any self-cleaning products as these chemicals may compromise the integrity of the glass.

Glass is soft and porous and can absorb harsh cleaners which can result in a permanent dirty or cloudy looking glass.



Shower Hardware Care & Maintenance

With the proper care and maintenance, your shower hardware can last the lifetime of your shower enclosure. A regular, thorough cleaning with soap and water is the most effective way to keep your hardware looking new.

Thoroughly wet the surface of the hardware and clean gently using a soft, clean sponge or cloth. Rinse with fresh, clean water and wipe dry with a soft clean cloth or a microfiber cloth.

Note: Please do not use any kind of harsh or abrasive chemical on the hardware or the finish may be permanently damaged.

Notes + Sketches

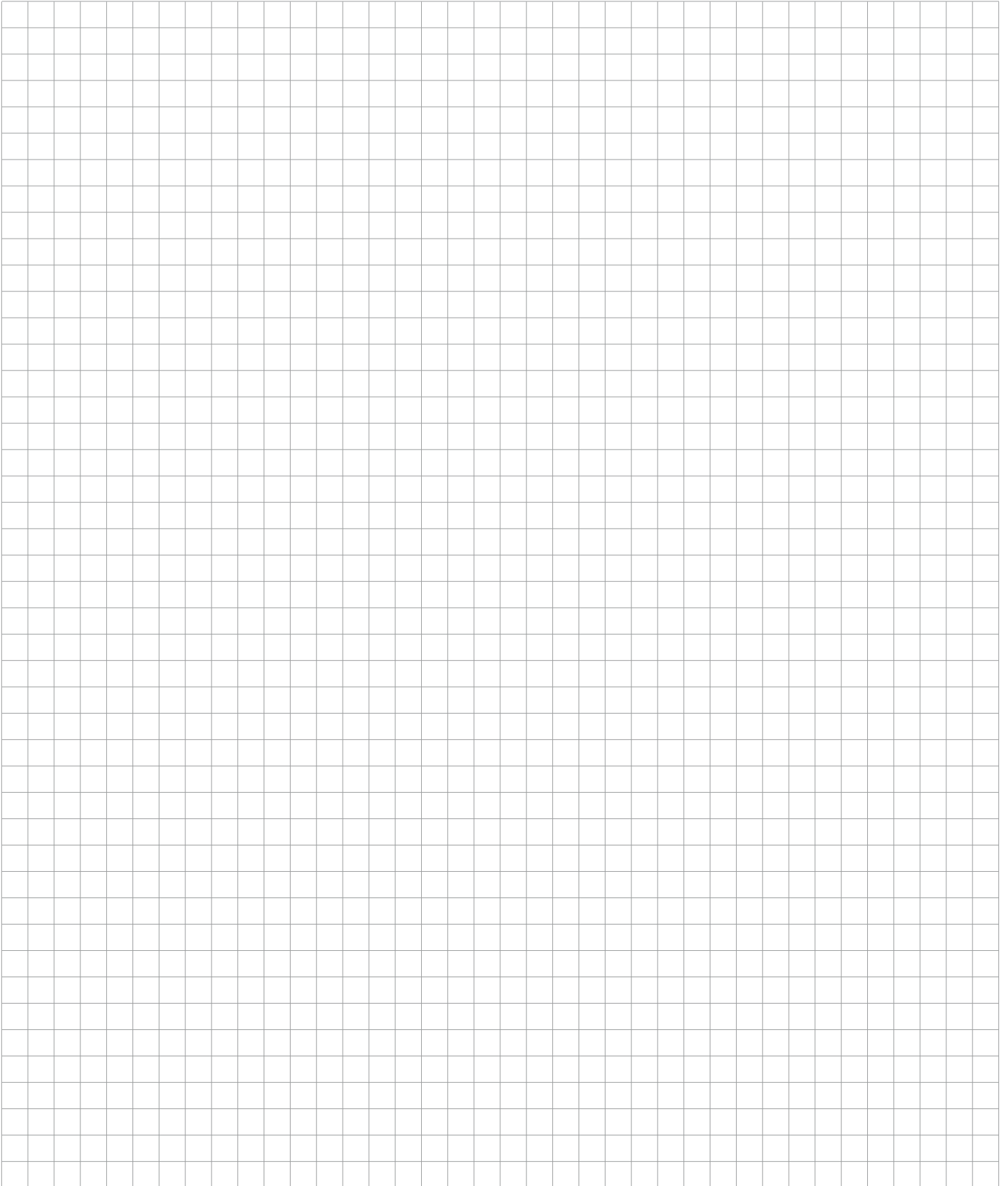

portals

luxury hardware & accessories

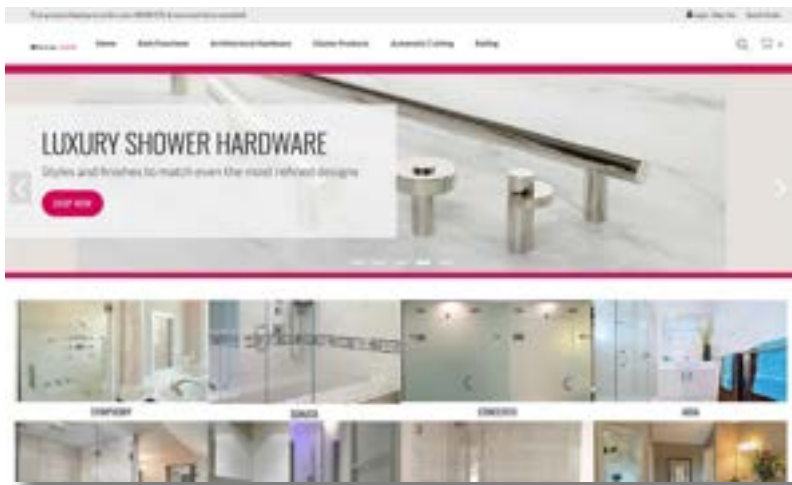

Please visit portalshardware.com for:

- Complete Product Listing
- Pricing
- Specifications
- Templates
- Stock Finishes
- Purchasing
- Door and Wall Mounting Options

Portals Hardware
925 Lydia Ave
Kansas City, MO 64106 USA

support@portalshardware.com
phone: 816.942.7413
fax: 816.942.7414